

MORPHOAGRONOMIC CHARACTERIZATION AND GENETIC VARIABILITY ANALYSIS OF COMMON BEAN LANDRACES IN KASHMIR HIMALAYAS: IMPLICATIONS FOR YIELD ENHANCEMENT

SIDRA NASAR AND GHULAM MURTAZA

Department of Botany, University of Azad Jammu and Kashmir Muzaffarabad 13100, Pakistan

*Corresponding author's email: sidnasar88@gmail.com

Abstract

Common bean landraces cultivated in the Himalayan mountains of Kashmir region constitute a diverse gene pool with broad genetic variations having immense potential in crop improvement and yield enhancement programs. Current study was designed with the core objective to evaluate the morphoagronomic traits of common beans landraces cultivated in the state of Azad Jammu and Kashmir (AJK) Pakistan and identify the best performing genotypes to for breeding purposes to achieve sustainable crop production. The collected Genotypes were evaluated for a total of 25 morpho-agronomic traits including 13 quantitative traits along with 12 qualitative traits by employing randomized complete block (RCBD) experiment design. Considerable variations were observed in the qualitative traits with the highest frequency value recorded for indeterminate climber growth habit, small to medium seed size. Maximum variations were recorded in the investigated quantitative traits including Plant height (59.1-315.73 cm), hundred seed weight (20.7-65.67 g), seed yield per Plant (8.16-36.15 g); whereas moderate levels of variation were recorded in Days to flowering (52.9-70.8); Leaf Length (7.11-12.15 cm), Leaf width (5.4-10.7 cm), Pod length (8.17-15.4 cm), Seed length (10.18-17.35 mm), Seed width (6.16-8.86 mm), Pod width (0.85-1.72 cm), Pod beak length (0.45-0.96). Analysis of genetic variability revealed that Hundred seed weight, Seed yield per plant and Plant height traits exhibited high heritability values with maximum scores of Phenotypic as well as genotypic coefficients of variation, also having highest (>50%) values of genetic advance. Our study has identified KEL-1, NGR-2, HAL-5, and KEL-9 genotypes to be best suitable for cultivation in the rainfed Himalayan mountain agriculture systems in the region having maximum yield outputs. Multivariate ordination analysis identified Plant height, hundred seed weight, and seed yield as principal traits having maximum potential for the crop improvement. Findings provide valuable scientific information about the important yield traits of common bean landraces that with dynamic implications for crop improvement and food security in the mountain agriculture systems across the region.

Key words: Crop breeding; Genetic variability; Heritability; Land Races; Seed yield.

Introduction

The common bean (*Phaseolus vulgaris* L.) is an important crop belonging to the family Fabaceae originated from Mesoamerica (Rendon-Anaya *et al.*, 2017). *Phaseolus vulgaris* is cultivated widely to fulfill human food demand across the globe being a rich source of protein (Anunda *et al.*, 2019), carbohydrates, fibers, iron and multivitamins (Beebe *et al.*, 2013). *Phaseolus vulgaris* is a diverse taxon having a wide range of morphological and genetic variations owing to its large geographical distribution from temperate to subtropics and adaptation in several agroecological zones (Darkwa *et al.*, 2016). Though the modern plant breeders have developed a large number of common bean varieties, but farmers in the Himalayan region still prefer to grow local landraces for their self-consumption as well as revenue generation (Burle *et al.*, 2010).

Annual Common bean production in Pakistan is estimated to be 140000 tons with a yield of 0.6t/ha only as compared to the global annual production of 27 million tons with yields around 2.5-5 t/ha (Anon., 2018). The low production of common beans is due to inappropriate farming approaches, insect-pest diseases, instability in price and lack of improved high yield genotypes (Mitrus *et al.*, 2020). Morphological characterization is the fundamental step involved in the germplasm exploration in order to identify desired traits to develop high yielding genotypes (Santalla *et al.*, 2004). The selection of superior genotypes depends upon the extent of genetic variability and the rate

of traits being inherited (Scarano *et al.*, 2014). Therefore, it becomes critical to observe the association between genetic variability and yield components for effective exploitation of genetic resources in the enhancement of plant breeding (Farshadfar *et al.*, 2013; Langat *et al.*, 2019). Consequently, genetic variability and their corresponding heritability is the key factor in the grain yield improvement (Ghimire & Mandal, 2019).

Phaseolus vulgaris is the only pulse crop that has been cultivated in the mountains of Azad Jammu and Kashmir since centuries commonly cultivated within the Maize crop fields (Qureshi *et al.*, 2002). The bean cultivation in the Kashmir region follows a conservative approach mainly relying on the local landraces due to better performance of local seeds adapted in a wide range of geographical and climatic variables (Amanullah *et al.*, 2016). The low yield of common bean landraces is a key challenge to be addressed which demands immediate yield improvement through breeding programs (Rani *et al.*, 2014). Literature review reveals that no previous research has been made on common bean trait evaluation in the mountainous region of Azad Jammu and Kashmir indicating a significant knowledge gap. Therefore, the current research focused to investigate the morpho-agronomic performance of 40 common bean accessions with the aim to explore traits variation in the crop used for the selection of elite genotypes with high yield. The specific objectives of the study also included to unveil the genetic divergence of different qualitative and quantitative morphoagronomic traits of common bean

landraces and analyze the genetic variability of the traits in order to determine variance components and identify high yielding accessions among landraces.

Materials and Methods

Study area: The research has been carried out in the state of Azad Jammu and Kashmir in north of Pakistan geographically located in the western Himalayan mountainous region. A total of 40 common bean accession were collected from 10 bean growing areas in 5 districts of the AJK during the year 2018 (Fig. 1). The bean growing areas are characterized with humid-temperate climates with average summer temperatures around 30-35 C° having an annual rain fall of 1300 mm (Pak-Met, 2019). The common beans are cultivated as an

intercrop with Maize crop in the small scale mountainous agriculture systems throughout the region.

Experimental design: A total of 40 common bean accessions were collected locally from different mountainous and remote areas of AJK. The seeds were grown under field conditions in randomize complete block design for two consecutive growing seasons during 2019 and 2020 at University of AJK Muzaffarabad (34°23. 09 N, 73°27. 55 E) followed by selfing and single plant selection. The plant seeds were sown by hand and placing plant to plant distance of 30 cm with 60 cm distance between rows and a row length of 5 m for each accession. The soil of the study field was rich organic and moderate alkaline. Management of crop field was carried out by regularly practiced weeding and insect/pest checks.

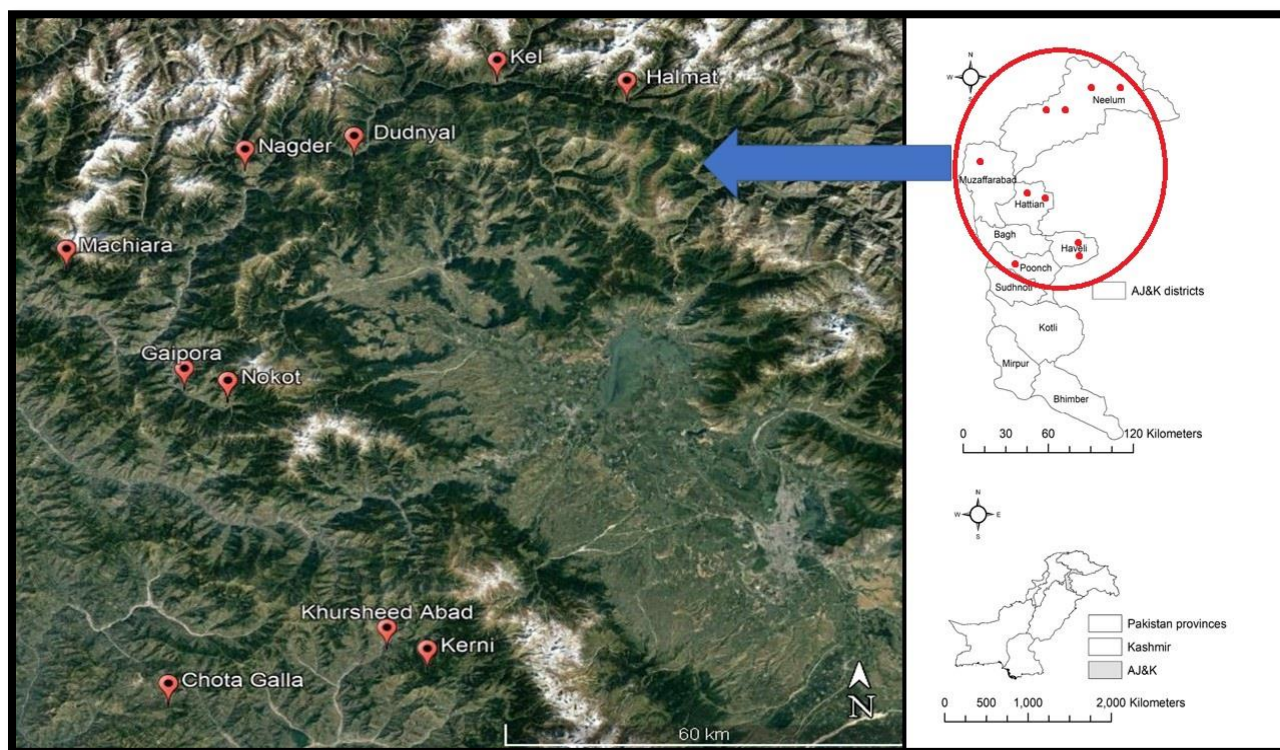

Fig. 1. Map of the Study area and sampling sites for the collection of 40 common accessions from AJK region, Pakistan (Source: Google earth Pro 7.3.3.7786).

Data collection: As per field design, a total of 10 plants were selected for recording each plant trait by following the International Board for Plant Genetic Resources *Phaseolus* L. Descriptor list (Anon., 1982). A total of 25 morphoagronomic traits of common beans were investigated following Anon., (1982) including 13 qualitative and 12 quantitative traits. *Qualitative traits* were recorded based on visual evaluation which included Growth Habit, Hypocotyl pigmentation, Leaf Colour, Leaf Shape, Flower Colour, Pod colour, Pod curvature, Seed primary colour, Seed secondary colour, Seed pattern, Seed shape, Seed size. *Quantitative traits* were counted, measured, and weighed including Days to flowering (DTF), Plant height (PH), Leaflet length (LL), Leaflet width (LW), Stem girth (SG), Pod length

(PL), Pod width (PW), Pod beak length (PBL), Seed length (SL), Seed width (SW), Hundred seed weight (HSW), Number of seeds per pod (SPP), and Seed yield per plant (SYPP).

Analysis of genetic variability: Genetic variability parameters were calculated as following. Phenotypic and genotypic coefficient of variation was calculated as described by Burton (1953) as *Phenotypic coefficient of variation* (PCV) = $\sqrt{V_p} / (\bar{x}) \times 100$. *Genotypic coefficient of variation* (GCV) = $\sqrt{V_G} / (\bar{x}) \times 100$. Where V_p = Phenotypic variance; V_G = Genotypic variance; \bar{x} = Grand mean. The PCV and GCV values were categorized as low (0–10%), moderate (10–20%), and high (20% and above) as outlined by Sivasubramanian & Madhavamenon (1978). *Heritability* was estimated as the ratio of total genotypic variance to the phenotypic variance according

to (Lush, 1940) as $h^2 = V_G/V_P \times 100$; Where $H^2 = \%$ Broad sense heritability. The heritability percentage was categorized as low (0- 30%), moderate (30 – 60%), and high $\geq 60\%$ as described by (Robinson, 1949). *Expected Genetic advance* (GA) was calculated as $GA = K\sqrt{V_P}h^2$ (bs); Where $K=1.40$ intensity of selection at 5%, V_P = phenotypic variance, and h^2 (bs) = heritability in broad sense. *The Genetic Advance as percent of Mean* (GAM) was calculated as $GAM = GA / (\bar{x}) \times 100$. Where GA = genetic advance and \bar{x} grand mean. GAM was classified as low= <10%, moderate= 10–20%, and high= >20% following Robinson *et al.*, (1949).

Statistical analysis

Analysis of variance (ANOVA) was performed for statistical analysis by using software Statistix 8.1 (McGraw-Hill, 2008). The results of the quantitative traits were expressed as mean, range, and coefficient of variance. Primary data was further subjected to Pearson correlation test and multivariate analysis techniques including Principal Component Analysis (PCA) and UPGMA Cluster Analysis by using PAST (past version 4.4) statistical program (Hill & Gauch, 1980).

Results

Frequency distribution of qualitative traits:

Considerable variations were recorded for investigated 13 qualitative traits in the 40 common bean accessions. Indeterminate climber *Growth Habit* was recorded with highest frequency value for 75% accessions followed by ovate Leaf Shape recorded in 72.5% accessions. About 60% of the accessions exhibited white Flower Colour with absence of secondary seeds colour and pattern. Pod Colour trait revealed green colour as predominant recorded in 57.5% accessions whereas green Stems Colour and green Hypocotyl Pigmentation was observed in 55% of the accessions. About 52.5% accessions showed green Leaf Colour whereas 50% accessions had curved pod curvature. Maroon and Pale brown colours were recorded as the most prevalent Primary seed coat colours (17.5% each) accessions followed by 12.5% accessions with red, black, and brown colour each, respectively. Seed Shape traits revealed Kidney shape being the largest class with 45% accessions followed by Truncate fastigiate in 22.5% of the accessions. Analysis of Seed Size classes showed small and medium seed sizes per 100 seed weight shown by 35% accessions each followed by large seed size in 30% accessions (Fig. 2).

Quantitative analysis of agromorphological traits: The mean, range and coefficient of variation exhibited significant variations among the investigated accessions (Table 2). PH, HSW, SYPP, PBL and SG were identified as principal traits showing maximum variations among the investigated accessions. KEL-1, HAL-5, KEL-9 and NGR-2 genotypes were identified to have maximum scores for yield traits including SYPP and HSW whereas highest PH (>300cm) values were recorded in LPA-7,

KEL-9, DUD-3, NGR-3, FK-6 and NGR-5 genotypes (Table 1). Moderate variations were recorded in LW, LL, SL, PW and PL traits whereas minimum variations were observed in SPP, SW and DTF traits among the investigated common bean. Results showed an average HSW value of 33.36 g for the accessions with the highest value of 65.67 g for KEL-1 and the minimum value as 20.7 g for DUD-6. The investigated accessions showed an average SYPP value of 17.19 g with the highest value of 36.15 g in KEL-1 whereas the lowest value as 8.16 g in FK-5 (Table 1).

Pearson's correlation test of the quantitative traits:

The results of quantitative morphological traits were subjected to Pearson's correlation test (2-tailed; $p < 0.01\%$ and $p < 0.05\%$) to explain the pairwise variability the traits which identified significant correlation among the variables. The vegetative growth traits including PH and SG showed strong significant correlation followed by the leaf traits including LL and LW. Yield traits including SYPP and HSW also exhibited significant correlation along with pod and seed characters including PL, PW, SL, SW and SW. A strong negative correlation was identified between DTF and SPP traits whereas a weak negative correlation between SPP and PBL as well as PH and DTF (Fig. 3).

Multivariate ordination analysis:

PCA was applied on the quantitative morpho-agronomic traits of the 40 common bean accessions to identify the correlations among the genotypes and the best performing traits. PCA explained about 96.1 % of the total variance in the dataset for first 3 PC's indicating the strength of the test. PCA biplot identified the best performing genotypes including KEL-9, LPA-7, DUD-3, NGR-3, FK-6, NGR-10, DUD-5, and NGR-2 distinctly placed on the right side of X-axis having maximum scores for the investigated morphological traits. PCA revealed a strong affinity among KEL-1 and HAL-5 accessions with HSW trait placed in close proximity along Y-axis whereas HAL-3 was closely correlated with SYPP trait. PH trait showed maximum vector length along X-Axis having significant correlation with LPA-7, KEL-9, DUD-3, NGR-3, FK-6, and NGR-5 genotypes (Fig. 4).

The UPGMA cluster analysis of quantitative traits grouped the accessions in identifiable prominent clusters according to the similarity. Cluster "A" was further subdivided into 2 subclusters comprised of 16 genotypes having higher scores of vegetative as well as yield traits including HSW, SYPP, SW and PH. The accessions were mainly grouped together on the basis of PH, HSW, DTF and SYPP. Cluster "B" comprise of 6 genotypes grouped together mainly due to having highest values of DTF. Cluster "C" comprised of a large aggregation of 15 accessions further subdivided into smaller units mainly attributed of having moderate to lower values of yield and vegetative growth traits. KEL-4, KEL-6 and HAL-4 genotypes were separated very distinctly forming a small cluster "D" on the extreme left attributed to their lowest PH values (Fig. 5).

Table 1. Values of the quantitative agronomorphological traits of Common Bean accession from Azad Jammu and Kashmir, Pakistan.

Accessions	PH (cm)	LL (cm)	SG (cm)	SL (mm)	HSW (g)	SPP	SYPP (g)	DTF	SW (mm)	PW (cm)	PBL (cm)	PL (cm)	LW (cm)
NGR-2	287.35±3.00	10.77±0.41	2.37±0.10	15.08±0.38	52.02±1.94	5.08±0.34	33.70±2.64	57.70±1.98	8.09±0.15	1.52±0.11	0.85±0.10	13.34±1.21	8.04±0.85
NGR-3	309.10±2.09	11.70±0.94	3.25±0.21	11.12±1.16	46.65±2.61	4.63±0.31	16.09±2.69	64.65±1.85	7.89±0.79	1.52±0.18	0.63±0.07	11.80±0.77	9.90±0.69
NGR-4	293.13±2.31	7.67±0.99	3.25±0.24	11.92±0.77	21.18±1.55	4.22±0.52	23.38±1.75	55.52±2.11	7.39±0.71	1.39±0.27	0.93±0.13	10.26±0.51	5.90±0.32
NGR-5	304.05±3.06	9.27±0.54	2.60±0.06	12.15±0.38	28.52±2.53	4.97±0.47	15.39±2.03	58.20±1.66	7.33±0.22	1.19±0.08	0.66±0.08	11.43±0.36	7.44±0.67
NGR-6	239.72±3.67	9.30±0.75	1.97±0.12	10.22±0.35	28.13±2.46	4.45±0.68	16.77±2.03	58.20±2.11	6.49±0.29	0.85±0.10	0.46±0.05	9.16±0.85	7.50±0.69
NGR-7	222.25±3.56	7.63±0.53	2.67±0.24	11.78±0.13	30.12±3.32	5.02±0.46	23.04±1.86	62.80±2.00	7.43±0.14	1.42±0.18	0.54±0.07	11.80±0.50	6.14±0.57
NGR-8	249.30±3.94	8.97±0.82	2.03±0.16	12.28±0.57	34.98±2.78	5.15±0.36	22.61±1.88	56.00±2.29	7.23±0.40	1.29±0.19	0.53±0.08	11.46±0.78	6.77±0.73
NGR-9	287.12±3.27	8.07±0.63	2.78±0.17	11.28±0.18	23.68±1.07	4.28±0.56	13.83±1.64	53.78±0.51	6.56±0.43	1.19±0.12	0.51±0.05	10.63±0.75	6.30±0.66
NGR-10	295.28±3.68	12.17±0.46	3.35±0.14	12.88±1.03	42.30±2.81	3.87±0.54	20.65±2.12	67.00±2.22	8.46±0.40	1.62±0.18	0.50±0.05	11.26±0.67	10.67±0.62
NGR-11	269.92±2.46	10.80±1.00	1.83±0.25	13.12±0.78	29.33±2.27	3.75±0.52	14.09±2.01	61.77±2.87	7.63±0.14	1.45±0.08	0.91±0.10	11.03±0.55	8.40±1.37
NGR-12	243.62±1.88	9.07±0.57	1.63±0.10	12.15±0.70	22.52±1.61	4.72±0.69	12.03±2.02	61.72±2.17	7.46±0.26	1.45±0.18	0.75±0.08	10.36±0.69	7.14±0.61
DUD-3	302.65±30.30	10.12±1.31	2.40±0.18	11.10±0.11	40.92±10.54	5.12±0.57	15.87±1.89	60.43±1.61	7.54±0.60	1.42±0.32	0.57±0.09	11.38±0.85	8.02±1.19
DUD-5	281.75±16.78	11.20±0.52	2.35±0.33	11.12±0.60	47.03±3.06	4.40±0.86	14.55±3.10	64.58±2.03	7.79±0.46	1.57±0.29	0.64±0.05	10.50±1.12	9.00±0.85
DUD-6	215.23±29.14	8.50±2.09	1.93±0.48	11.42±0.48	25.40±11.78	4.93±0.56	15.61±1.12	67.72±2.73	6.83±0.94	1.50±0.29	0.57±0.08	11.01±0.60	7.30±1.53
DUD-7	204.53±1.74	8.90±0.68	1.85±0.23	11.00±0.58	29.72±5.71	4.43±0.74	14.07±2.35	66.70±1.84	6.29±0.77	1.05±0.39	0.57±0.11	10.06±1.06	6.80±0.33
DUD-9	245.88±19.56	8.60±0.75	2.08±0.23	12.35±0.48	23.40±3.40	4.27±0.49	17.40±1.72	55.42±5.04	7.11±0.32	1.19±0.12	0.49±0.05	11.06±0.53	6.49±0.61
DUD-10	278.42±12.93	9.13±0.42	2.25±0.23	12.32±1.17	30.57±5.96	3.90±0.73	12.37±4.68	62.95±7.43	7.04±0.58	1.35±0.19	0.86±0.22	10.41±1.52	6.15±0.60
DUD-13	194.00±2.65	7.13±0.44	2.40±0.21	10.85±0.38	23.25±1.76	3.87±0.60	10.13±2.16	69.08±2.27	7.09±0.31	1.35±0.23	0.49±0.03	8.16±0.65	5.94±0.39
KEL-1	226.72±2.45	11.23±0.60	2.82±0.29	17.38±1.08	65.47±2.21	4.78±0.50	35.98±2.23	62.97±1.28	8.43±0.37	1.72±0.14	0.55±0.05	12.33±1.42	9.44±0.39
KEL-4	136.07±1.95	10.30±0.39	1.75±0.21	11.82±0.47	43.32±2.29	3.97±0.74	20.37±3.26	70.83±1.61	7.96±0.35	1.49±0.14	0.88±0.11	10.90±1.04	7.60±0.53
KEL-6	120.55±2.31	9.00±0.96	1.65±0.10	11.72±0.20	28.88±1.99	4.30±0.48	10.44±1.78	59.43±2.18	7.39±0.18	1.39±0.10	0.45±0.05	10.90±0.66	7.10±1.17
KEL-7	147.17±2.00	8.07±0.43	1.68±0.21	11.25±0.18	21.98±2.30	5.03±0.49	19.97±2.08	59.88±3.37	6.86±0.19	1.32±0.14	0.55±0.04	10.06±0.38	6.40±0.39
KEL-9	315.25±1.30	8.40±1.21	2.38±0.19	10.52±0.33	47.52±3.07	5.00±0.50	18.47±2.11	64.43±2.36	6.73±0.41	1.42±0.09	0.55±0.05	13.40±0.45	6.94±0.41
KEL-10	142.68±1.81	8.20±0.46	1.62±0.12	10.62±0.45	22.98±2.51	3.73±0.58	14.16±2.73	66.58±1.71	7.36±0.40	1.42±0.09	0.68±0.07	9.90±0.58	6.14±0.40
HAL-3	223.95±2.84	11.43±0.50	1.73±0.20	12.72±0.33	47.28±4.21	4.83±0.43	12.23±2.94	66.48±2.69	8.89±0.59	1.62±0.09	0.58±0.05	11.90±0.40	6.38±0.11
HAL-4	109.45±2.27	8.57±0.95	1.30±0.15	11.52±0.50	22.80±1.55	5.10±0.46	16.33±1.79	56.32±2.14	6.89±0.18	1.12±0.18	0.48±0.04	10.90±1.35	7.74±0.29
HAL-5	224.80±3.80	9.87±0.61	2.27±0.15	16.65±0.50	63.70±1.95	5.15±0.46	25.67±1.21	65.18±0.98	7.83±0.35	1.42±0.14	0.65±0.13	14.23±0.47	8.23±0.17
LPA-2	270.78±2.83	9.93±0.58	2.53±0.10	12.35±0.20	27.47±2.69	4.92±0.37	15.25±1.42	64.30±1.96	7.59±0.46	1.42±0.26	0.47±0.06	11.06±0.86	7.14±1.40
HAL-1	142.48±2.63	10.17±0.56	1.95±0.16	12.55±0.92	30.62±1.72	4.27±0.29	14.12±1.56	64.95±1.69	7.43±0.29	1.45±0.10	0.69±0.09	8.90±0.63	7.23±0.35
KEL-13	168.92±3.57	8.33±1.35	1.72±0.19	11.42±0.18	21.42±1.17	3.80±0.56	16.70±1.89	66.88±2.28	7.33±0.22	1.45±0.10	0.59±0.06	9.23±0.98	7.13±0.11
LPA-7	316.08±2.33	11.23±0.44	2.23±0.19	11.28±0.53	47.58±4.01	4.93±0.40	21.60±0.62	64.68±2.50	7.83±0.34	1.45±0.18	0.48±0.06	12.23±1.11	9.54±0.66
LPA-8	225.67±2.67	9.00±1.95	2.28±0.17	11.82±0.43	22.27±1.40	4.37±0.57	21.21±3.26	67.65±2.04	6.73±0.18	1.25±0.16	0.48±0.06	10.40±0.40	7.74±1.67
LPA-10	218.83±3.29	9.10±0.52	2.65±0.14	11.72±0.62	28.98±2.67	4.97±0.36	11.08±0.99	69.05±1.96	7.76±0.48	1.45±0.18	0.49±0.04	9.06±0.33	6.90±0.32
MAC-1	185.57±2.80	9.80±1.02	1.98±0.15	11.38±0.27	21.45±1.34	4.78±0.35	14.27±2.32	56.80±2.36	6.46±0.34	1.25±0.10	0.50±0.10	8.73±0.74	8.40±0.73
MAC-2	291.80±1.94	8.17±0.90	2.28±0.17	12.15±0.23	31.15±2.18	4.15±0.42	11.75±2.01	67.63±2.13	7.36±0.21	1.55±0.12	0.49±0.03	10.66±0.70	6.24±0.53
FK-5	272.35±2.17	8.33±0.78	2.27±0.15	12.48±1.42	28.37±1.84	4.27±0.29	7.99±0.76	68.52±2.31	8.49±0.51	1.55±0.23	0.50±0.03	10.06±1.45	6.47±0.48
FK-6	304.77±2.81	10.43±0.61	3.20±0.21	14.68±0.93	41.88±0.60	3.53±0.48	8.76±1.99	64.80±1.65	7.66±0.59	1.55±0.10	0.50±0.04	11.40±0.40	8.80±1.54
RWK-3	157.30±2.94	7.33±0.64	2.22±0.19	10.58±0.21	23.35±1.54	3.75±0.58	13.75±1.34	65.33±1.97	7.36±0.59	1.29±0.19	0.71±0.10	10.90±0.40	5.37±0.58
RWK-4	196.60±3.37	7.97±1.21	1.70±0.20	11.15±0.44	22.62±1.34	4.48±0.53	12.14±1.85	68.28±2.40	7.59±0.22	1.45±0.10	0.48±0.07	9.90±0.80	6.27±1.30
RWK-5	166.75±2.46	9.27±1.66	1.62±0.19	12.98±1.12	27.77±1.37	4.05±0.23	22.74±1.64	68.78±1.43	7.46±0.63	1.52±0.24	0.70±0.07	9.90±0.99	7.87±1.65
Mean	232.20±60.36	9.33±1.52	2.22±0.53	12.12±1.61	32.96±12.10	4.48±0.68	16.91±6.26	63.35±5.08	7.43±0.71	1.40±0.24	0.60±0.15	10.80±1.46	7.37±1.41

Key: Plant height, DTF: Day to flowering (days), LL: Leaflet length (cm), LW: Leaflet width (cm), SG: Stem girth (cm), PL: Pod length (cm), PW: Pod width (cm), PBL: Pod beak length (cm), SL: seed length (mm), SW: seed width (mm), HSW: hundred seed weight (g), SPP=Seed per pod, SYPP= Seed yield per plant (g)

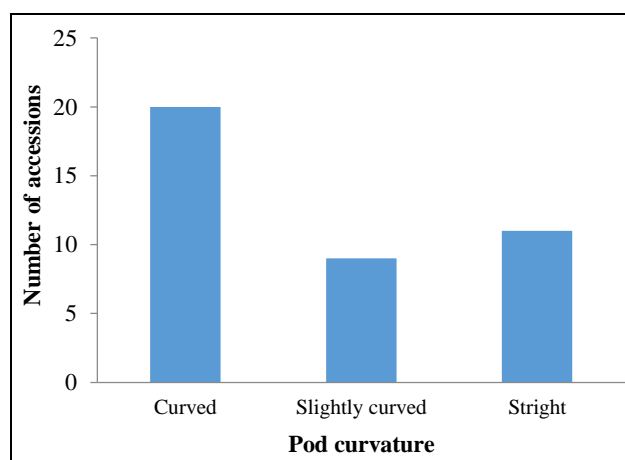
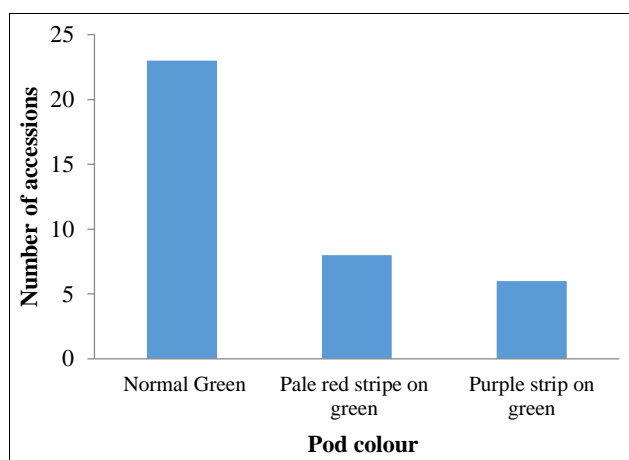
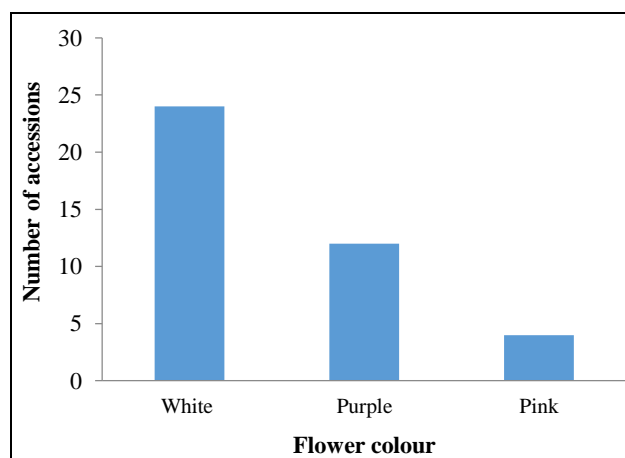
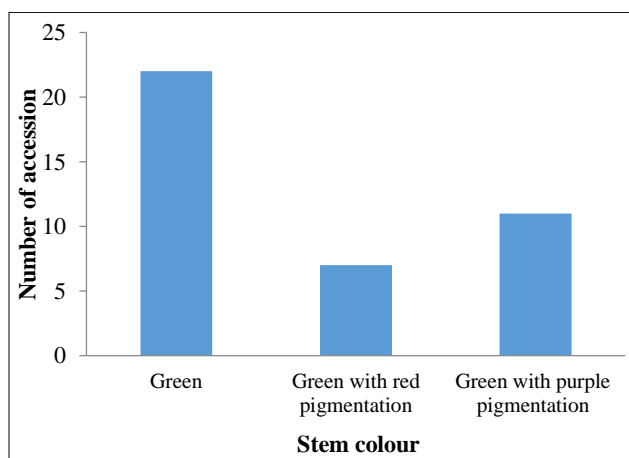
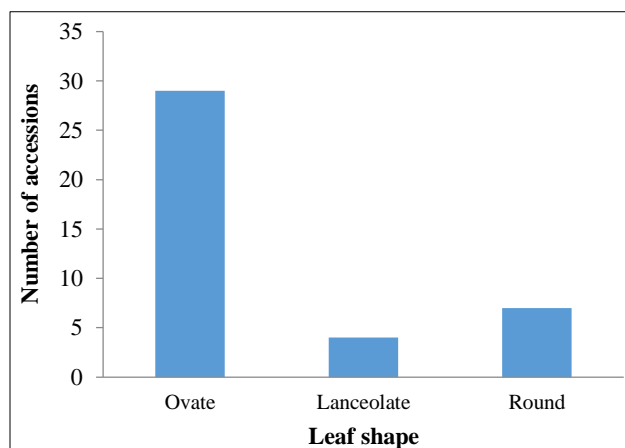
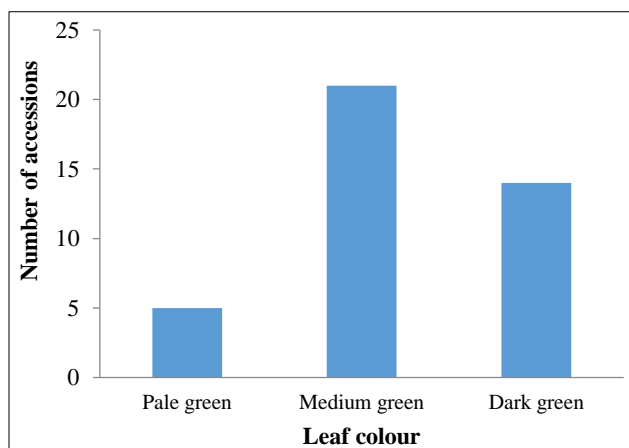
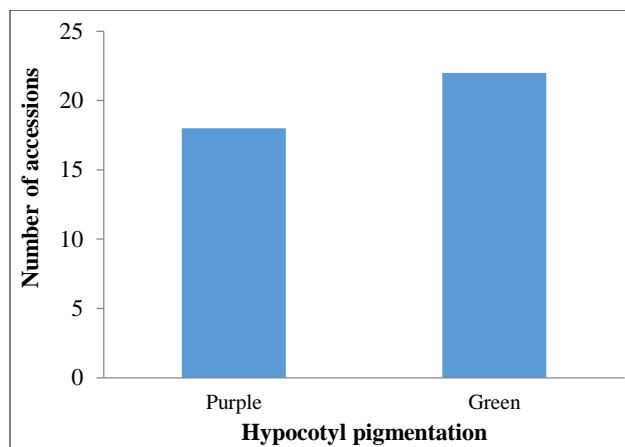
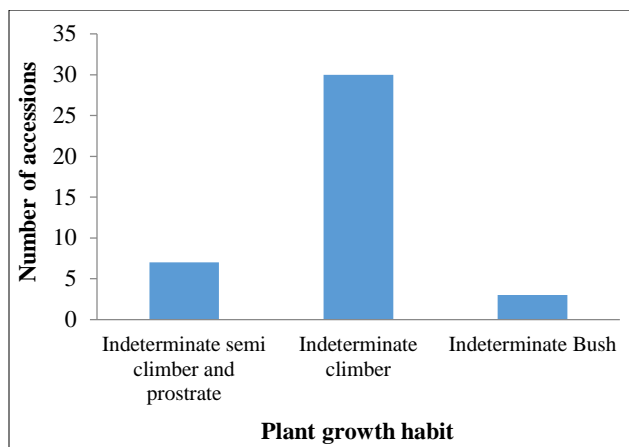

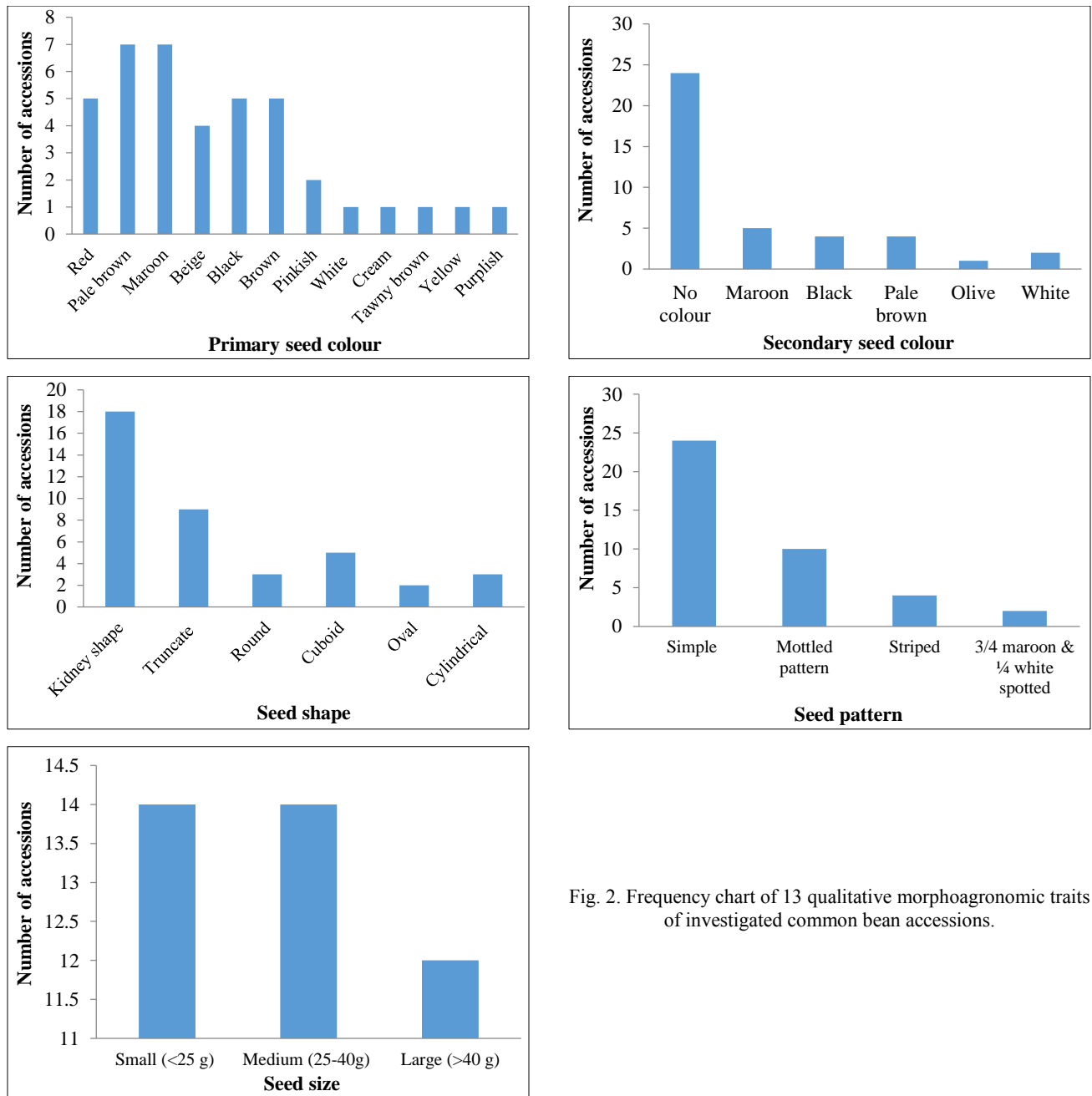

Fig. 2. Frequency chart of 13 qualitative morphoagronomic traits of investigated common bean accessions.

Table 2. Mean, range, coefficient of variance and genetic variability parameters for 12 morpho-agronomic traits of common bean accessions.

Traits	Min	Max	Mean	Std. error	Coeff. Var	PCV	GCV	$h^2_{(BS)}$	GAM
Plant height	59.10	315.7	227.70	11.11	30.86	36.60	36.58	0.99	51.22
Leaflet length	7.11	12.15	9.32	0.21	14.11	21.17	19.11	0.81	26.75
Leaflet width	5.40	10.70	7.40	0.19	16.54	24.89	22.41	0.81	31.37
Stem girth	1.30	3.35	2.22	0.08	22.84	32.43	31.58	0.95	44.21
Pod length	8.17	15.40	10.86	0.22	12.95	17.46	15.91	0.83	22.27
Pod width	0.85	1.72	1.40	0.03	12.73	19.91	17.15	0.74	24.01
Pod beak length	0.45	0.96	0.60	0.02	23.60	33.98	31.74	0.87	44.43
Seed length	10.10	17.35	12.16	0.24	12.37	17.97	17.24	0.92	24.13
Seed width	6.16	8.86	7.45	0.10	8.43	12.21	11.00	0.81	15.40
Hundred seed weight	20.70	65.67	33.36	1.94	36.69	51.65	51.18	0.98	71.65
Seed per pod	3.58	5.28	4.46	0.08	11.53	17.62	14.74	0.70	20.63
Days to flowering	52.90	70.80	63.34	0.75	7.47	10.65	10.34	0.94	14.48
Seed yield per plant	8.16	36.15	17.19	0.97	35.64	50.27	49.77	0.98	69.67

Note: V_G : V_p : Phenotypic variance, Genotypic variance, PCV: Phenotypic coefficient of variation, GCV: Genotypic coefficient of variation, $h^2_{(BS)}$: Heritability, GA: Genetic advance, GAM%: Genetic advance as percentage of mean

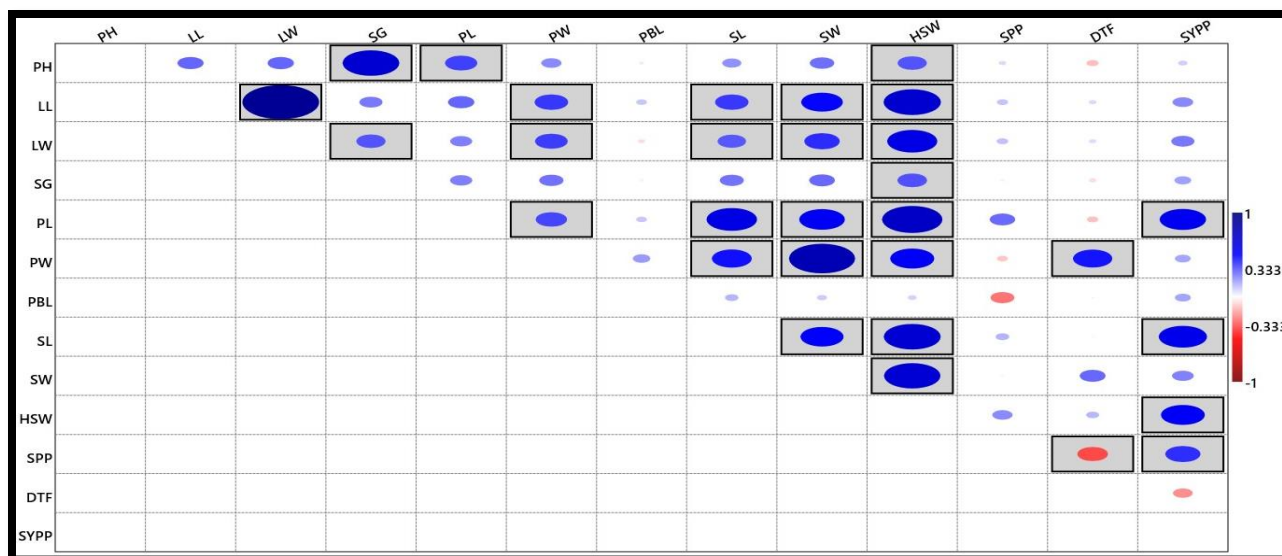

Fig. 3. Pearson's linear correlation test ($p>0.05$) of the quantitative traits of Common beans.

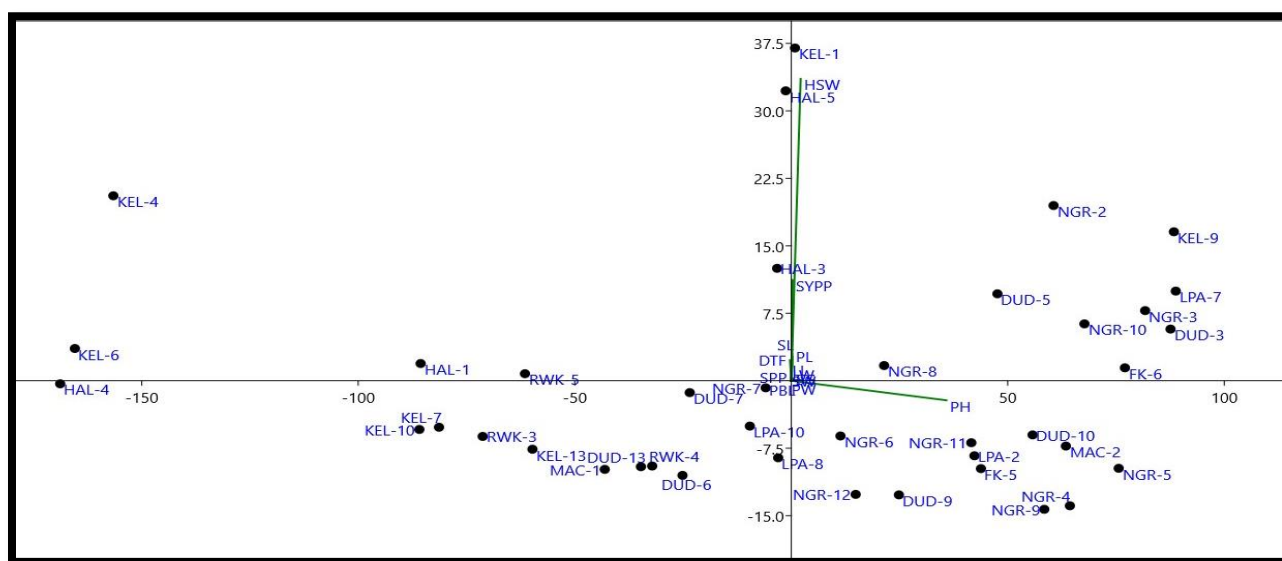

Fig. 4. Principal component analysis biplot of morpho-agronomic traits of the investigated *P. vulgaris* accessions.

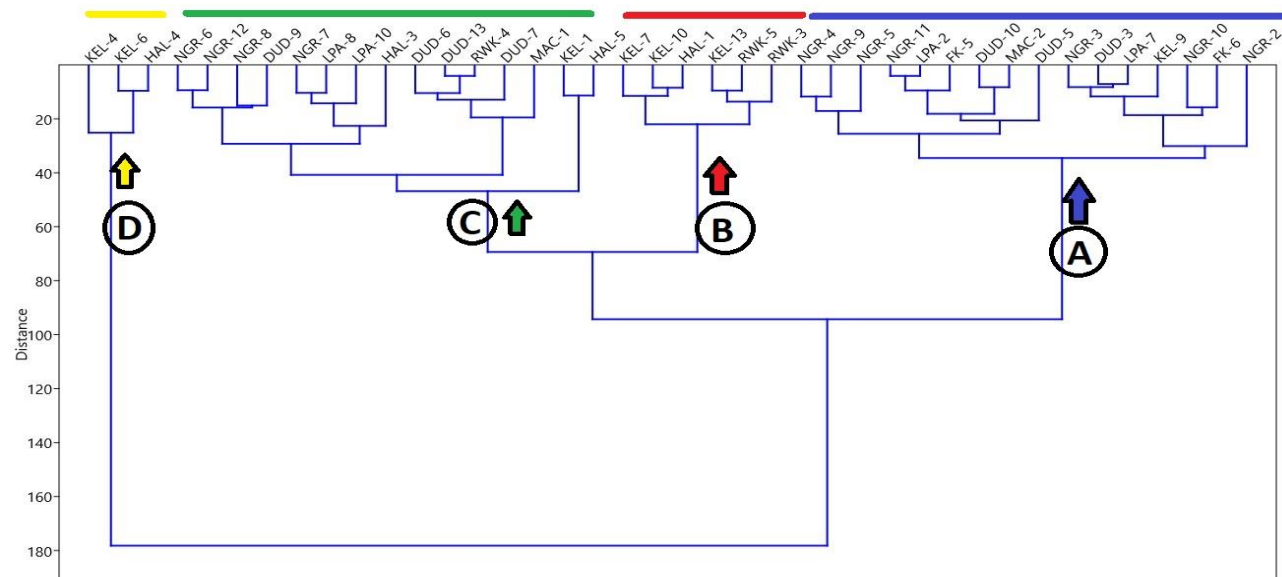

Fig. 5. UPGMA Cluster Analysis dendrogram of the investigated common bean accessions from AJK region, Pakistan.

Genetic variability parameters of the traits: The investigated genetic variability parameters of the quantitative traits showed broad variations among the investigated accessions. HSW trait showed highest PCV and GCV values of 51.65 and 51.18 respectively with a GAM value of 71.65. SYPP was the 2nd prominent trait having values of PCV 50.27, GCV 49.77 and GAM as 69.67 whereas PH also appeared to be significant with PCV 36.6, GCV 36.58, and GAM of 51.22, respectively. PBL, SG, LW, LL, SL, PW, and PL traits showed moderate values of genetic variability parameters whereas SPP, SW and DTF traits were identified as the traits having lowest values (Table 2).

Discussion

Phaseolus vulgaris accessions have been cultivated in the state of Azad Kashmir since centuries as a summer season intercrop with Maize (Qureshi *et al.*, 2002). The traditional *P. vulgaris* landraces have been persistent in cropping system due to their better performance, cultural values, and inherent quality (Nawaz *et al.*, 2019). Morphological approaches are widely used to get preliminary plant growth data and to discriminate genotypes in order to understand the genetic diversity level (De-La Fuente *et al.*, 2013).

Our results revealed climbing growth habit as dominant, characterized with high yield, late maturity, and prolonged life cycle (Rana *et al.*, 2015). This Indeterminate semi climber growth habit is reported to be the best adapted for high altitude with cooler of the Himalayan region as compared to lowland valleys (Aryal *et al.*, 2020). Furthermore, intercropping system of beans with maize prefers the climbing growth habit because of its compatibility and fitness, making the climber type bean varieties best fit option in the predominant maize-bean intercropping system of Kashmir (Garcia *et al.*, 1997). Results revealed higher values for Days to flowering trait as the mountainous landraces of common beans take longer time to flower as compared to the varieties cultivated in warm plains (Gepts & Debouck, 1991). Our DTF values are in accordance with Gupta *et al.*, (2019) who have reported average DTF values of 53.25 for common beans in Indian plains.

Agroclimatic conditions and farmer preferences are the important factors that determine the common bean distribution pattern in a specific area (Nadeem *et al.*, 2020). With reference to farmers preference, it was observed that seed size and seed color were the major factors that determine the distribution of accessions with most accessions have climber growth habit that reflects late maturity. Locals mainly use common beans for fresh pods which directly corresponds to our results with high pod length and pod width, in line with findings of Balkaya & Ergun (2008). A great diversity of seed colour and pattern was observed in the common bean landraces owing to their long history of domestication and trait selection (Bruno *et al.*, 2018). Seed colour was the most diverse qualitative trait in our findings having highest number of frequency classes i.e., 12 colors (Fig. 2). This diversity in seed colour has also been reported from European (Zeven *et al.*, 1999) and South America

(Andean) varieties (Blair *et al.*, 2009) reflecting a global consumer preference of these principal seed coat colours (Meza *et al.*, 2013; Saba *et al.*, 2016).

Quantitative morphoagronomic parameters showed significant variations among the investigated accessions evident from the mean, range, and CV scores. Seed traits are considered as principal common bean attributes being the major determinants of the yield as well as economic viability (Rana *et al.*, 2015; Sexton *et al.*, 1997; Gepts *et al.*, 1988). Results revealed an average 100 seed weight of 33.36 g which corresponds to Sofi *et al.*, (2011) who have reported a HSW of ± 40.6 g for the common bean accessions in Indian Kashmir Region. Seed yield per Plant (SYPP) trait reflected the productivity of individual crop plants (Scarano *et al.*, 2014). Our results showed an average SYPP of 17.19 g with highest values of 36.15 g. Seed size is another important trait which influences the farmer's choices while seed selection and crop improvement (Papa & Gepts, 2003). Investigated accessions appeared to be equally divided into small (35%), medium (35%) and large (30%) seed size classes.

Correlation analysis among the morphological traits is vital to analyze the inherent trends among the closely associated attributes with dynamic implications in crop breeding (Ozer *et al.*, 2010). Our findings revealed significant correlations among the yield traits including HSW and SYPP with seed and leaf traits including PL, LL, SL, SW, LW and PW. The statistical significance of these traits indicated their importance in the determination of yield and suggests that these strongly correlated traits could be helpful in the selection of associated traits interchangeably in breeding programs (Rana *et al.*, 2015; Okii *et al.*, 2014). Associated traits selected concurrently are always preferred for selection (Loko *et al.*, 2018).

Application of the multivariate techniques on the crop growth parameters can prove to be significant to identify the best performing varieties and selection of the desired traits (Szilagy *et al.*, 2011). Ordination analysis validates the results of our field experiment based upon the data of morphoagronomic traits (Hornakova *et al.*, 2003). PCA identified the best performing genotypes in the dataset including KEL-9, LPA-7, DUD-3, NGR-3, FK-6, NGR-10, DUD-5 and NGR-2 which appeared to have highest scores for the yield traits. Similarly, cluster analysis also aggregated the investigated genotypes based upon the trait similarity into identifiable groups which could be helpful in the identification of existing landraces and upgradation of desired traits.

Analysis of genetic variability parameters is vital to determine the potential of traits to be used in crop improvement and yield enhance programs (Wondwosen & Abebe, 2017). Quantification of the genetic variability holds key significance in the crop breeding programs as it reveals the genetic structure of populations (Lima *et al.*, 2012). Our findings revealed significant genetic variability among the investigated agromorphological traits of common bean land races in Kashmir region. It is among the most significant findings of the current study that the yield traits including HSW and SYPP showed highest values of genetic variability parameters including GCV, PCV as well as GAM%. It is worth mentioning that the principal vegetative growth trait i.e., PH also showed

a high value of genetic variability synchronized with the yield attributes, which also indicates simultaneous inheritance of these traits in nature with additive gene effects (Langat *et al.*, 2019). These traits prove to be favorable for common bean progress by phenotypic selection as well as high expected genetic gain through selection (Dursun, 2007).

Conclusions

Common bean accessions collected from the AJK region revealed significant variations in the 25 agromorphological traits. Climber habit, green colour in pod, leaf, and stem along with maroon and beige seed colours were predominant qualitative traits whereas PH, HSW, SYPP were the significant quantitative traits. Genetic variability analysis revealed HSW, SYPP and PH traits having high levels of variability. The higher estimates of PCV, GCV, H^2 (bs) and GA% significant additive gene variance that could be utilized for the enhancement of acquired traits. Seed yield per plant, Plant height and hundred seed weight could be promising for improving crop yield. On the basis of mean performance, high seed yield per plant and hundred seed weight were exhibited by the accessions KEL-1 followed by NGR-2, HAL-5 and KEL-9 were found to be suitable for cultivation in rainfed common bean system. The high levels of heritability in grain yield attributes indicate towards the great potential of common bean crop improvement in the AJ&K region, with great implications in bean producing mountain agricultural systems across the region.

References

- Aklade, S.A., H.E. Patil, M. Sarkar and B.K. Patel. 2018. Genetic variability, correlation and path analysis for yield and yield related traits in vegetable type french bean (*Phaseolus vulgaris* L.). *Int. J. Pure App. Biosci.*, 6(6): 25-32.
- Ali, A., S.A. Khan, S. Ali, N. Ali, S.M. Khan, I. Hussain, T. Ahmad, A. Basit and H. Raza. 2020. Morphological and biochemical characterization of locally available kidney beans. *Pure Appl. Biol.*, (PAB), 9(1): 528-537.
- Amanullah, A., A. Khan, K. Nawab and Q. Sohail. 2016. Performance of promising common bean (*Phaseolus vulgaris* L.) germplasm at Kalam-Sawat. Pakistan. *J. Biol. Sci.*, 9: 2642-2646.
- Anonymous. 1982. International Board for Plant Genetic Resources (IBPGR). Descriptors List for *Phaseolus vulgaris*, Secretariat Rome, Italy.
- Anonymous. 2018. FAOSTAT. FAO statistical databases. Retrieved from <http://faostat3.fao.org/home/E> Accessed 26 April 2018.
- Anunda, H.N., E.N. Nyaboga and N.O. Amugune. 2019. Evaluation of genetic variability, heritability, genetic advance and correlation for agronomic and yield components in common bean landraces from South western Kenya. *J. Plant Breed. Crop Sci.*, 11(5): 144-157.
- Aryal, K., S. Poudel, P. Chaudhary, R.P. Chaudhary, K.H. Ghimire, D.S. Shrestha and B.K. Joshi. 2020. Agromorphological Diversity of High Altitude Bean Landraces in the Kailash Sacred Landscape of Nepal. *J. Nepal Agric. Res. Counc.*, 6: 1-13.
- Balkaya, A., A. Ergün. 2008. Diversity and use of pinto bean (*Phaseolus vulgaris*) populations from Samsun, Turkey. *N.Z.J. Crop Hort. Sci.*, 36: 189-197.
- Bassett, M.J. 1995. The dark corona character in seed coats of common bean cosegregates with the pink flower allele *vlae*. *J. Amer. Soc. Hort. Sci.*, 120(3): 520-522.
- Beebe, S., I. Rao, M. Blair and J. Acosta. 2013. Phenotyping common beans for adaptation to drought. *Front. Physiol.*, 4: 35.
- Blair, M.W., L.M. Diaz, H.F. Buendia and M.C. Duque. 2009. Genetic diversity, seed size associations and population structure of a core collection of common beans (*Phaseolus vulgaris* L.). *Theor. Appl. Genet.*, 119(6): 955-972.
- Bressani, R. 1993. Grain quality of common beans. *Food Rev. Int.*, 9(2): 237-297.
- Bruno, A., E. Katungi, N.T. Stanley, M. Clare, M.G. Maxwell, G. Paul, R. Patrick and E. Richard. 2018. Participatory farmers' selection of common bean varieties (*Phaseolus vulgaris* L.) under different production constraints. *Plant Breed.*, 137(3): 283-289.
- Burle, M.L., J.R. Fonseca, J.A. Kami and P. Gepts. 2010. Microsatellite diversity and genetic structure among common bean (*Phaseolus vulgaris* L.) landraces in Brazil, a secondary center of diversity. *Theor. Appl. Genet.*, 121(5): 801-813.
- Burton, G.W. and D.E. Devane. 1953. Estimating heritability in tall fescue (*Festuca arundinacea*) from replicated clonal material 1. *Agronomy J.*, 45(10): 478-481.
- Calles, T. 2016. The International Year of Pulses: What are they and why are they important. *Agric. Dev.*, 26: 40-42.
- Ceolin A.C.G., M.C.G. Vidigal, P.S.V. Filho, N.L.M. Kvitisc and A. Gonela. 2007. Genetic divergence of the common bean (*Phaseolus vulgaris* L.) group carioca using morpho-agronomic traits by multivariate analysis. *Hereditas.*, 144: 1-9.
- Choudhury, A.K., A. Karim, M. Haque, Q.A. Khaliq, J.U. Ahmed and M. Hossain. 2011. Genotypic variability in plant water status of French bean under drought stress. *J. Crop Sci. Biotechnol.*, 14(1): 17.
- Darkwa, K., D. Ambachew, H. Mohammed, A. Asfaw and M.W. Blair. 2016. Evaluation of common bean (*Phaseolus vulgaris* L.) genotypes for drought stress adaptation in Ethiopia. *Crop J.*, 4(5): 367-376.
- De La Fuente, M., A.M. Gonzalez, A.M. De Ron and M. Santalla. 2013. Patterns of genetic diversity in the Andean gene pool of common bean reveal a candidate domestication gene. *Mol. Breed.*, 31(3): 501-516.
- Dursun A. 2007. Variability, heritability and co-relation studies in bean genotypes. *World J. Agric. Sci.*, 3: 12-16.
- Evans, A.M. 1980. *Structure, variation, evolution, and classification in Phaseolus*. UK Royal Botanic Gardens.
- Evans, A.M. Plant architecture and physiological efficiency in the field bean. (1973). In: (Ed.): Wall, D Potentials of Field Bean and other Food Legumes in Latin America. Cali, Colombia: CIAT, pp. 279-284.
- Farshadfar, R., S.B. Hussain, I. Khaliq and S. Ullah. 2013. Study of inheritance for grain yield and related traits in bread wheat (*Triticum aestivum* L.). *SABRAO J. Breed Genet.*, 45(2): 283-90.
- Gepts P. 1988. A Middle American and an Andean common bean gene pool. In: (Ed.): Gepts, P. Genetic Resources of *Phaseolus* Beans, Dordrecht: Springer. pp. 375-390.
- Gepts P. and D. Debouck. 1991. Origin, domestication, and evolution of the common bean (*Phaseolus vulgaris* L.). In: (Eds.): van Schoonhoven, A. & O. Voyses, Common Beans: Research for Crop Improvement. Colombia: CIAT., 7-53.
- Ghimire, N.H. and H.N. Mandal. 2019. Genetic variability, genetic advance, correlation and heritability of cold tolerance lentil (*Lens culinaris* Medic.) genotypes at High Hill of Nepal. *Int. J. Adv. Res. Biol. Sci.*, 6(11): 1-10.
- GoAJK. 2018. Azad Jammu & Kashmir, At a Glance. AJK Bureau of Statistics. Planning & Development Department Muzaffarabad.

- Gupta N., S.M., Zargar, R.K. Salgotra, M.K. Sharma and S.K. Gupta. 2019. Variability estimates for yield determining characters in common bean (*Phaseolus vulgaris* L.). *Int. J. Curr. Microbiol. Appl.*, 8(8): 47-57.
- Hill, M.O. and H.G. Gauch. 1980. Detrended correspondence analysis: an improved ordination technique. In: (Ed.): Pielou, E.C. The Interpretation of Ecological Data: A Primer on Classification and Ordination. Dordrecht: Springer. pp. 47-58.
- Hornakova, O., M. Zavadna, M. Zakova, J. Kraic and F. Debre. 2003. Diversity of common bean landraces collected in the western and eastern Carpatien. *Czech J. Genet. Plant Breed.*, 39(3): 73-83.
- Langat, C., O. Ombori, P. Leley, D. Karanja, R. Cheruiyot, M. Gathaara and B. Masila. 2019. Genetic variability of agronomic traits as potential indicators of drought tolerance in common beans (*Phaseolus vulgaris* L.). *Int. J. Agron.*, 2019: 1-8.
- Lima, M.S.D., J.E.D.S. Carneiro, P.C.S. Carneiro, C.S. Pereira, R.F. Vieira and P.R. Cecon. 2012. Characterization of genetic variability among common bean genotypes by morphological descriptors. *Crop Breed. Appl. Biotechnol.*, 12(1): 76-84.
- Loko, L.E.Y., A. Orobiyi, A. Adjatin, J. Akpo and J. Toffa. 2018. Morphological characterization of common bean (*Phaseolus vulgaris* L.) landraces of Central region of Benin Republic. *J. Plant Breed. Crop Sci.*, 10(11): 304-318.
- Lush, J.L. 1940. Intra-sire correlations or regressions of offspring on dam as a method of estimating heritability of characteristics. *J. Anim. Sci.*, 1940(1): 293-301.
- Lynch, M. and B.G. Milligan. 1994. Analysis of population genetic structure with RAPD markers. *Mol. Ecol.*, 3(2): 91-99.
- Mallor, C., M. Barberan and J. Aibar. 2018. Recovery of a common bean landrace (*Phaseolus vulgaris* L.) for commercial purposes. *Front. Plant Sci.*, 9: 1440.
- McGraw-Hill, C. 2008. Statistix 8.1 (Analytical Software, Tallahassee, Florida). Maurice/Thomas text.
- Meza, N., J.C. Rosas, J.P. Martin and J.M. Ortiz. 2013. Biodiversity of common bean (*Phaseolus vulgaris* L.) in Honduras, evidenced by morphological characterization. *Genet. Resour. Crop Evol.*, 60(4): 1329-1336.
- Mitrus, M., A. Wojtowicz, S. Kocira, A. Kasprzycka, A. Szparaga, T. Oniszczuk, M. Combrzyński, K. Kupryaniuk and A. Matwijczuk. 2020. Effect of extrusion-cooking conditions on the pasting properties of extruded white and red bean seeds. *Int. Agrophysics*, 34(1): 25-32.
- Mohammadi, S.A. and B.M. Prasanna. 2003. Analysis of genetic diversity in crop plants salient statistical tools and considerations. *Crop Sci.*, 43(4): 1235-1248.
- More, A.D. and A.T. Borkar. 2016. Analysis of genetic variability, heritability and genetic advance in *Phaseolus vulgaris* L. *Int. J. Curr. Microbiol. Appl. Sci.*, 5: 494-503.
- Nadeem, M.A., T. Karaköy, M.Z. Yeken, E. Habyarimana, Ru stu Hatipo ̃glu, V. Çiftçi, M. A. Nawaz, F. Sönmez, M.Q. Shahid, S.H. Yang, G. Chung and F.S. Baloch. 2020. Phenotypic Characterization of 183 Turkish common bean accessions for agronomic, trading, and consumer-preferred plant characteristics for breeding purposes. *Agronomy*, 10: 272.
- Nawaz, I., F.M. Farhatullah, S. Ali and G.M. Ali. 2019. Primary evaluation of seed characteristics of common bean landraces collected from Himalaya region of Pakistan. *Sarhad J. Agric.*, 36(1): 33-41.
- Okii, D., P. Tukamuhabwa, T. Odong, A. Namayanja, J. Mukabaranga, P. Paparu and P. Gepts. 2014. Morphological diversity of tropical common bean germplasm. *Afr. Crop Sci. J.*, 22(1): 59-68.
- Ozer, S.; T. Karaköy, F. Toklu, F.S. Baloch, B. Kilian and H. Özkan. 2010. Nutritional and physicochemical variation in Turkish kabuli chickpea (*Cicer arietinum* L.) landraces. *Euphytica.*, 175: 237-249.
- Papa, R. and P. Gepts. 2003. Asymmetry of gene flow and differential geographical structure of molecular diversity in wild and domesticated common bean (*Phaseolus vulgaris* L.) from Mesoamerica. *Theoretical & Applied Genetics*, 106(2): 239-250.
- Qureshi, A.H., S.S. Abbasi, M. Sharif, W. Malik and P.A. Council. 2002. Farmers practices of maize production and consumption in Azad Jammu and Kashmir Pakistan. *Pak. J. Agric. Sci.*, 39(4): 287-291.
- Rana, J.C., T.R. Sharma, R.K. Tyagi, R.K. Chahota, N.K. Gautam, M. Singh, P.N. Sharma and S.N. Ojha. 2015. Characterisation of 4274 accessions of common bean (*Phaseolus vulgaris* L.) germplasm conserved in the Indian gene bank for phenological, morphological and agricultural traits. *Euphytica*, 205(2): 441-457.
- Rani, S., H. Shah, U. Farooq and B. Rehman. 2014. Supply, demand, and policy environment for pulses in Pakistan. *Pak. J. Agri. Res.*, 27(2): 149-159.
- Rendon-Anaya, M., J.M. Montero-Vargas, S. Saburido-Alvarez, A. Vlasova, S. Capella-Gutierrez, J.J. Ordaz-Ortiz, O.M. Aguilar, R.P. Vianello-Brondani, M. Santalla, L. Delaye and A. Herrera-Estrella. 2017. Genomic history of the origin and domestication of common bean unveils its closest sister species. *Genom. Biol.*, 18(1): 1-17.
- Robinson, H.F., R.E. Comstock and P.H. Harvey. 1949. Estimates of heritability and the degree of dominance in corn. *Agron. J.*, 41(8): 353-359.
- Scarano, D., F. Rubio, J.J. Ruiz, R. Rao and G. Corrado. 2014. Morphological and genetic diversity among and within common bean (*Phaseolus vulgaris* L.) landraces from the Campania region (Southern Italy). *Scientia Horticulturae.*, 180: 72-78.
- Sexton, P.J., Peterson, C.M., Boote, K.J. and J.W. White. 1997. Early-season growth in relation to region of domestication, seed size, and leaf traits in common bean. *Field Crops Res.*, 52(1-2): 69-78.
- Sivasubramanian, S. and P. Madhavamenon. 1973. Combing ability in rice. *Madras Agric. J.*, 60: 419-421.
- Sofi, P.A., M.Y. Zargar, D. Debouck and A. Graner. 2011. Evaluation of common bean (*Phaseolus vulgaris* L.) germplasm under temperate conditions of Kashmir Valley. *J. Phyto.*, 3(8): 47-52.
- Szilagyi, L., S. Tayyar and M. Ciuca. 2011. Evaluation of genetic diversity in common bean (*Phaseolus vulgaris* L.) using RAPD markers and morpho-agronomic traits. *Rom. Biotechnol. Lett.*, 16(1): 98-105.
- Wondwosen, W. and B. Abebe. 2017. Genetic variability, heritability and genetic advance of some haricot bean (*Phaseolus vulgaris* L.) varieties at Bench-Maji Zone, Southwest Ethiopia. *Asian J. Crop Sci.*, 9: 133-140.
- Zeven, A.C., J. Waning, T. Van Hintum and S.P. Singh. 1999. Phenotypic variation in a core collection of common bean (*Phaseolus vulgaris* L.) in the Netherlands. *Euphytica*, 109(2): 93-106.